

# MotionPAC

# 4

4.1	Overview	P4-1-1
4.2	Software	P4-2-1
4.3	MP-8000 Series	P4-3-1



- MP-8343/8743 ----- P4-3-1
- MP-8353/8753 ----- P4-3-5

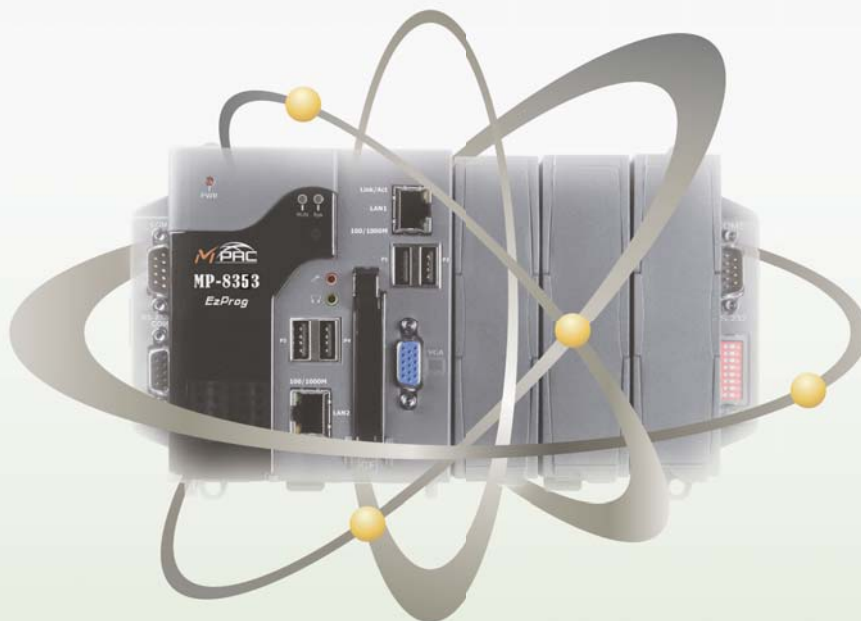

# 4.1. MP-8000 Overview

4

MotionPAC

• Overview



The MP-8000 is a motion programmable automation controller (MPAC) combining the functionality and openness of a PC with the reliability and simplicity of a programmable logic controller (PLC). The price-performance of the MPAC is unbeatable as compared with a PC, PLC, and DCS. The MP-8000 is designed for time critical and deterministic operations. Its field of application is unlimited: Factory automation, building automation, machine automation, laboratory automation, chemical industry, environmental monitoring, M2M, etc.

The MP-8000 is the new generation of programmable automation controller from ICP DAS. It is equipped with an AMD LX 800 CPU (500 MHz) or Atom Z500 serial, a Windows Embedded CE Operating System, various ports (VGA, USB, Ethernet, RS-232/RS-485) and 3 or 7 slots for high performance parallel-type I/O modules. Compared with the first generation of WinCon-8000 of ICP DAS, it not only improves the CPU performance but also has many additional reliability features, such as dual LAN, redundant power input, dual battery backup SRAM, etc.

**MP-8000 = IPC + I/O Cards**



Windows Embedded CE is a componentized, real-time, high performance, and highly reliable operating system. Windows CE 6 R3 delivers rich user experiences and a unique connection to Windows PCs, servers, services, and devices. The MP-8000 also supports the EzProg-I software development package offered by ICPDAS.

## Main Components:

1

Overview

**1 Main Control Unit (MCU)**

The MCU is the powerhouse of the MP-8000. Each MCU comprises a Central Processor Module (CPM), a power supply, and a 3 or 7-slot backplane for I/O modules. The CPM is a powerful integrated processing engine comprising a CPU, RAM and ROM, and communication interfaces for Ethernet, RS-485, RS-232 and FRnet.

**2 Embedded OS**

**Windows CE6**  
Windows CE 6 is the next generation of real-time OS offered by Microsoft. Windows CE 6 provides the software engineer with familiar tools and innovative technologies to reduce the development time of application software. The high performance and high reliability of the MP-8000 together with the Windows CE, makes the MP-8000 an ideal controller in the environment where time critical performance is required. Windows CE6 operating system kernel architecture supports up to 32,000 simultaneous processes, each of which runs in a 2GB virtual memory address space. This allows developers to incorporate larger number of complex applications into the MP-8000.

**3 I/O Modules**

There are two types of I/O modules: parallel and serial. The parallel modules (I-8K high profile series and motion series) are high-speed modules and have to be installed in the slots of the MP-8000. The serial I/O modules (I-87K high profiles series) can be installed in slots of the MP-8000 or expansion units (RU-87Pn).

**4 Remote I/O Expansion**

The MP-8000 has built-in RS-485 and Ethernet ports to connect to remote I/O units (RU-87Pn/ET-87Pn) or I/O modules (I-7000/M-7000/ET-7000). Installing CAN or FRnet communication modules, the MP-8000 can exchange data with CAN bus devices, remote I/O units or FRnet I/O modules for deterministic control system.

**5 Software Development Resources**

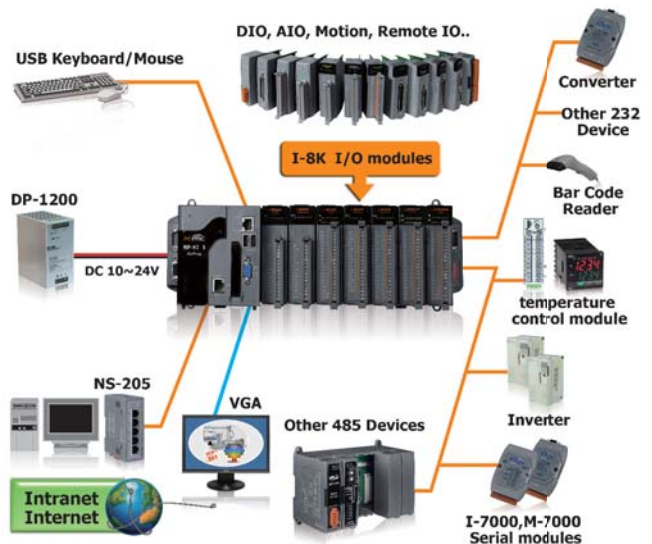

• Software



**The PAC Automation Solution EzProg-I:**

The EzProg-I is a total software solution for manufacturers or control system designers for system configuration, logic programming and HMI design. By using EzProg-I, engineers who are familiar with PLC systems can easily transfer their programming experience to ICP DAS's programmable automation control (PAC) solutions. The EzProg-I makes it much easier for customers to integrate PLCs and IT technologies into PAC.

The EzProg-I package contains many kinds of development tools and libraries, such as EzConfig, EzGo, EzMake, EzHMI, EzLib and EzCore. Based on these development resources, customers can directly configure and test the PAC channels and motion control modules without additional programming efforts. Moreover, the EzProg-I simplifies the I/O instruction and provides a PLC like I/O mapping table. It assists the system designers to develop and test the control system application.

**Development Structure:**

The EzProg-I structure is divided into three main parts:

**1. Upper layer: EzHMI**

EzHMI provides a number of ActiveX controls which allows the programmer to create a graphic interface on a WinCE system. The EzHMI object can be directly linked to an I/O mapping table which makes reading and writing of digital and analog I/O values very easy. The EzCore engine running in the background is responsible for updating the I/O table in real time.

**2. Intermediate layer: API**

The EzProg-I provides common APIs for accessing different I/O modules types. In the past, each module type could only be accessed via its own APIs, therefore different APIs had to be called for communicating with different modules. Now, the EzProg-I solves this problem and unifies all APIs. No matter with what I/O module you like to exchange data, only one API needs to be called. The EzProg-I enables PLC like programming by providing APIs for accessing EzCore registers which consists of the I/O mapping table and non-hardware related tables.

**3. Lower level: Logic control design**

The control software provides three different design methods:

- 3.1 8 Users thread procedures:  
The user thread only executes once. User threads have a lower priority than the other routines.
- 3.2 8 Executive routines with fixed interval time:  
Like a PLC scan method, after the system starts, it will create a thread that execute the user defined routine in a fixed time interval (minimum 2ms).
- 3.3 Hardware interrupt routine:  
The EzProg-I processes DI signal interrupt and Motion interrupt to execute the code added to the interrupt service routine.

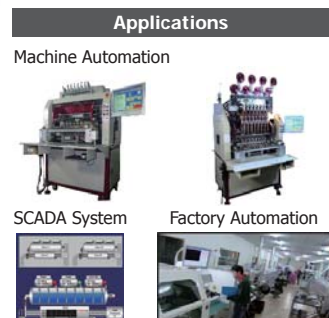
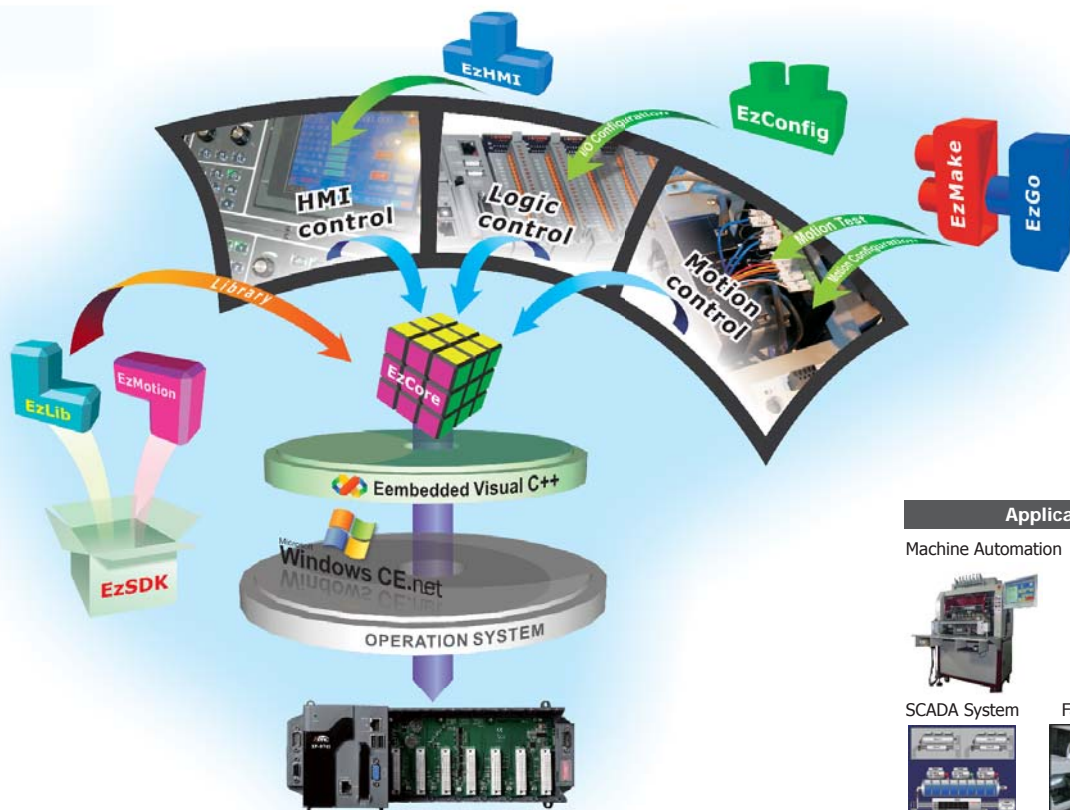

**Other features of EzProg-I:**

Public System Variable Type:	D (long), DW (Double WORD), W (Word), F (Float), B (Byte), M (Flag), S (Step), MSG (Message).
Retain Variable:	Most variable types have half retain variable blocks.
Timer Function:	Millisecond based timer.
Counter Function:	System counter (retain variable block is also available).
Multi-language Message:	Provide MLn file to edit UNICODE 1000 messages.

**Tools Support Guide: EzConfig, EzGo, EzMake**

Module\Tool	EzConfig	EzGo	EzMake
I-8092F-G	Yes (Note 1)	Yes	-
I-8094-G	-	Yes	-
I-8094F-G	Yes (Note 1)	Yes	-
I-8094A-G	-	Yes	Yes
I-8094H-G	-	Yes	Yes
I-8K Serial Modules	Yes	-	-
FRnet Remote Modules	Yes	-	-

**Note 1:** Only for FRnet

**The EzProg-I Tools**



**EzConfig**

The EzConfig is an I/O configuration tool to configure and test digital I/O, analog I/O, FRnet remote I/O and virtual I/O (M/D/F/DB/C/T/MSG etc.) for the I-8000 series modules and virtual I/O used in the EzProg-I.

**Functions of EzConfig:**

- Auto scan of I/O modules
- Load and save configuration data
- Retain data management
- Generate AES code
- Set initial virtual value
- Edit note
- Read/Write XML file



**EzGo**

ICP DAS provides a motion testing tool named EzGo for i-8094, i-8094F, i-8094A, i-8094H and i-8092F modules used in PACs for machine automation.



**EzMake**

The EzMake, the tool provided by ICP DAS for building motion systems, is designed for i-8094A and i-8094H modules used in the PACs for machine automation. The EzMake is a Macro editor for writing and testing motion commands sequence for the i-8094A and i-8094H modules.



**EzHMI**

The EzProg-I also provides many useful HMI ActiveX components for manufacturers and control system designers. It allows the programmer to create a graphic interface on a WinCE system without any additional programming efforts. It greatly improves the software programming productivity.

- EzHMI for application
- Easy properties setting
- Easy GUI color setting
- Displays I/O register data
- Direct I/O register value setting
- UNICODE Multi-Language
- Auto alarm flashing
- Dynamic BMP images
- Support Windows text fonts



**EzLib**

EzLib is a collection of reusable software components and assists software developers to write application programs for the Window CE platform.

- Data format transformation
- Date time function
- File I/O function
- Context drawing library
- BMP file drawing library
- FTP connection library
- TCP/IP library
- Trend graph library





**Highlight Information**

- Windows CE 6.0
- Hard Real-Time Capability
- Fast Boot Speed
- SQL Compact Edition 3.5
- EzProg-I development tools
- AMD LX 800 CPU (32-bit and 500MHz)
- VGA Port Output
- PC Power, Open System
- Redundant Power Input
- Operating Temperature: -25 ~ +75 °C



**Introduction**

The MP-8x43 is the new generation programmable automation controller of ICPDAS. It is equipped with a Windows Embedded CE 6.0 operating system running on an AMD LX 800 CPU (500 MHz), has got a wide range of ports (VGA, USB, Ethernet, RS-232/RS-485) and 3 or 7 slots for high performance parallel I/O modules (high profile I-8K series) and serial-type I/O modules (high profile I-87K I/O modules). Windows Embedded CE 6.0 has many advantages including hard real-time capability, small core size, interrupt handling at a deeper level, achievable deterministic control and low cost. Windows Embedded CE6.0, compared with CE5.0, updates its virtual memory architecture to increase system robustness and security.

**Features**

**Software**

- Microsoft Visual Studio 2008 VC++
- EzProg-I development tools:
  - EzConfig
  - EzHMI
  - EzGo
  - EzMake
  - EzLIB
- Software protection and license management

**Hardware**

- AMD LX 800 CPU (32-bit and 500 MHz)
- Memory size: RAM (512 MB)
- Built-In Flash Disk (4 GB)
- VGA Port x 1(Max 1600x1200)
- USB 2.0 Ports x 2
- 64-bit Hardware Serial Number
- Dual Watchdog Timers
- 5 Serial Ports (RS-232/RS-485)
- Dual Ethernet Ports (10/100M)
- Redundant Power Input
- Operating Range: -25 ~ +75 °C

**Applications**

Rich I/O Expansion Ability

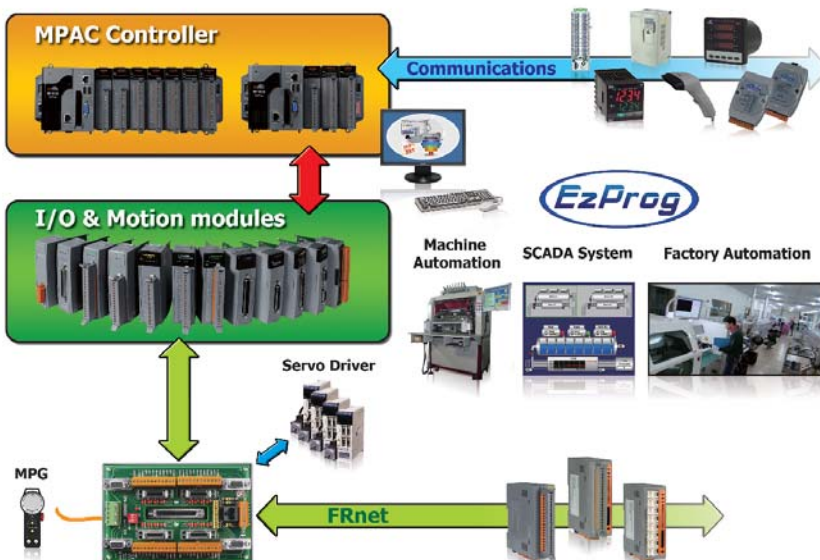

Specifications

4

MotionPAC

3

MP-8000 Series

Models		MP-8343	MP-8743
<b>System Software</b>			
OS	Windows CE 6.0 core version		
.Net Compact Framework	3.5		
Embedded Service	FTP Server, ASP (Java Script, VB Script), SQL Compact Edition 3.5		
SDK Provided	DII for Visual Studio .Net 2005/2008		
Multilanguage Support	English, German, French, Spanish, Russian, Italian, Japanese, Simplified Chinese, Traditional Chinese		
<b>CPU Module</b>			
CPU	AMD LX 800 processor		
System Memory	512 MB DDR SDRAM		
Dual Battery Backup SRAM	512 KB (for 5 years data retain while power off)		
Flash	4 GB as IDE Master		
EEPROM	16 KB Data Retention: 40 years; 1,000,000 erase/write cycles		
CF Card	Minimum 1 GB (support up to 32 GB)		
64-bit Hardware Serial Number	Yes, for Software Copy Protection		
Dual Watchdog Timers	Yes		
Rotary Switch	Yes (0 ~ 9)		
DIP Switch	Yes (8 bits)		
<b>VGA &amp; Communication Ports</b>			
VGA	Yes (resolution: 1024 x 768, 800 x 600, 640 x 480)		
Ethernet (Giga bit)	RJ-45 x 2, 10/100 Base-TX (Auto-negotiating, Auto MDI/MDI-X, LED indicators)		
USB 2.0	2		
COM 1	Internal communication with I-87K modules in slots		
COM 2	RS-232 (Rx/D, Tx/D and GND); non-isolated		
COM 3	RS-485	D2+, D2-; self-tuner ASIC inside	
	Isolation	3000 V <sub>oc</sub>	
COM 4	RS-232/RS-485 (Rx/D, Tx/D, CTS, RTS and GND for RS-232, Data+ and Data- for RS-485); non-isolated		
COM 5	RS-232 (Rx/D, Tx/D, CTS, RTS, DSR, DTR, CD, RI and GND); non-isolated		
<b>I/O Expansion Slots</b>			
Slot Number	3	7	
Support modules type	High profile modules only		
<b>Mechanical</b>			
Dimensions (W x L x H)	231 mm x 132 mm x 125 mm		355 mm x 132 mm x 125 mm
Installation	DIN-Rail or Wall Mounting		
<b>Environmental</b>			
Operating Temperature	-25 ~ +75 °C		
Storage Temperature	-30 ~ +80 °C		
Ambient Relative Humidity	10 ~ 90% RH, non-condensing		
<b>Power</b>			
Input Range	+10 ~ +30 V <sub>DC</sub>		
Isolation	1 kV		
Redundant Power Inputs	Yes, with one power relay (1 A @ 24 V <sub>DC</sub> ) for alarm		
Capacity	1.8A, 5V supply to CPU and backplane, 5.2A, 5V supply to I/O expansion slots, total 35 W		2.0A, 5V supply to CPU and backplane, 5.0A, 5V supply to I/O expansion slots, total 35 W
Consumption	14.4 W (0.6 A @ 24 V <sub>DC</sub> )		16.8 W (0.7 A @ 24 V <sub>DC</sub> )

MP-8343/8743

Appearance

MP-8343

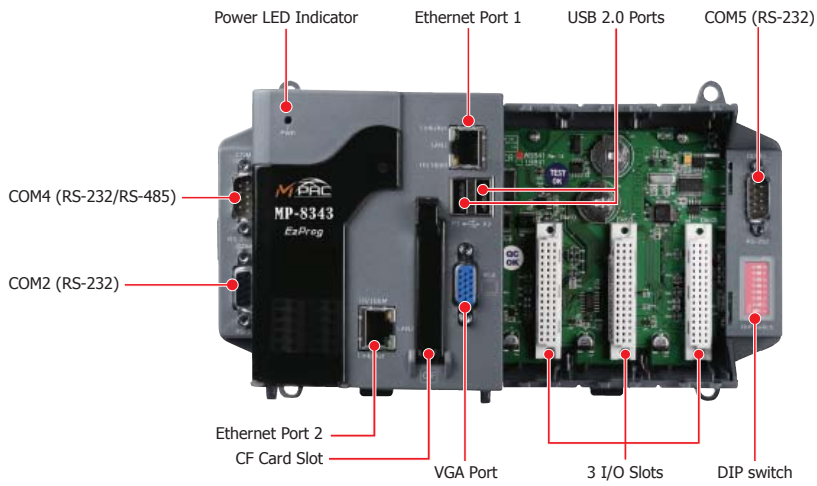

MP-8743

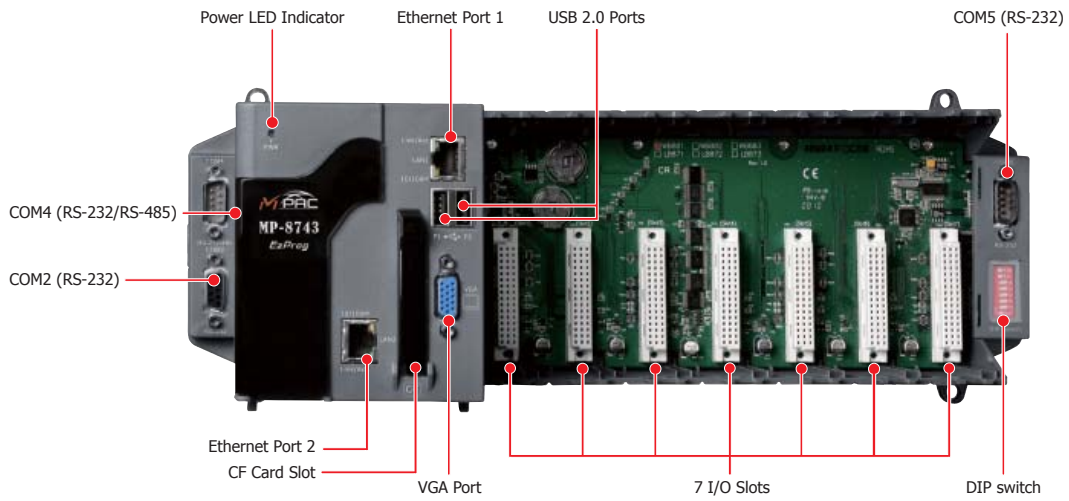

Pin Assignments

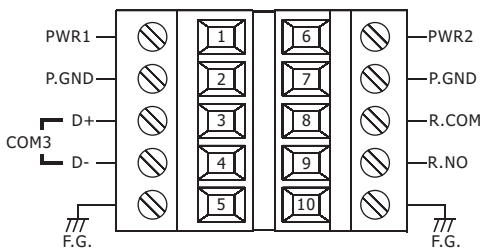

COM2: RS-232

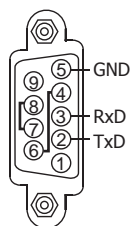

COM4: RS-232/RS-485

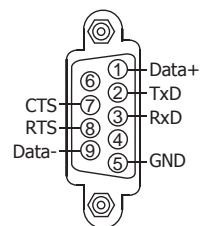

COM5: RS-232

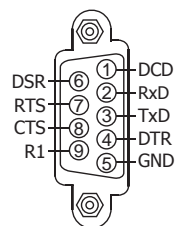

▣ Dimensions (Units: mm)

MP-8343

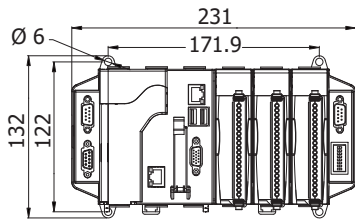

Front View

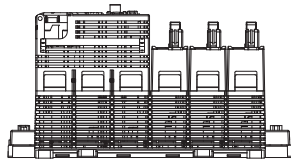

Bottom View

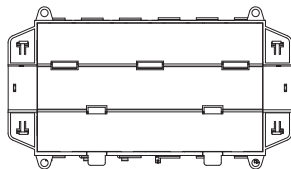

Rear View

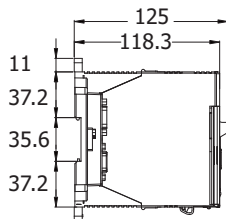

Left Side View

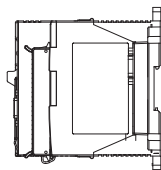

Right Side View

MP-8743

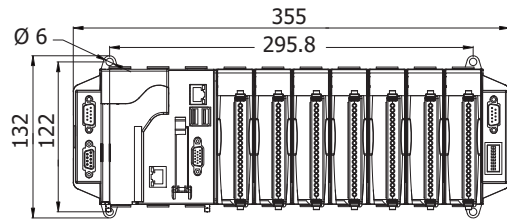

Front View

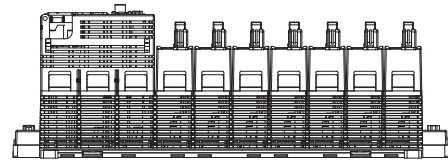

Bottom View

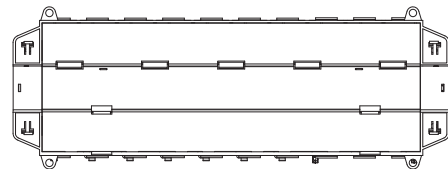

Rear View

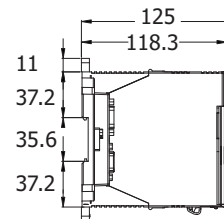

Left Side View

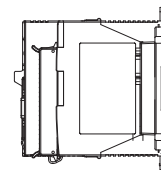

Right Side View

▣ Ordering Information

MP-8343 CR	Standard MP-8343 with 3 I/O Slots (Multilingual Version of OS) (RoHS)
MP-8743 CR	Standard MP-8743 with 7 I/O Slots (Multilingual Version of OS) (RoHS)

▣ Accessories

USB-2020 CR	USB Audio Device (RoHS)
USB-2560 CR	4-Port Industrial USB 2.0 Hub (RoHS)
NS-208 CR	8-Port Unmanaged Industrial 10/100 Base-TX Ethernet Switch (RoHS)
MDR-20-24 CR	24 V <sub>dc</sub> /1.0 A, 24 W Power Supply with DIN-Rail Mounting (RoHS)
MDR-60-24 CR	24 V <sub>dc</sub> /2.5 A, 60 W Power Supply with DIN-Rail Mounting (RoHS)





**Highlight Information**

- Windows CE 6.0
- Hard Real-Time Capability
- Fast Boot Speed
- SQL Compact Edition 3.5
- EzProg-I development tools
- Intel Atom Z510 CPU (1.1 GHz)
- Audio with Microphone-In and Earphone-Out
- VGA Port Output
- High Performance PC Power, Open System
- Redundant Power Input
- Operating Temperature: -25 ~ +75 °C



**Introduction**

MP-8x53 is the new generation programmable automation controller of ICPDAS. It is equipped with a Windows Embedded CE 6.0 operating system running on an Intel Atom Z500 Series processor, has got a wide range of ports (VGA, USB, Ethernet, RS-232/RS-485) and 3 or 7 slots for high performance parallel I/O modules (high profile I-8K series) and serial-type I/O modules (high profile I-87K I/O modules). Windows Embedded CE 6.0 has many advantages including hard real-time capability, small core size, interrupt handling at a deeper level, achievable deterministic control and low cost. Windows Embedded CE6.0, compared with CE5.0, updates its virtual memory architecture to increase system robustness and security.

**Features**

**Software**

- Microsoft Visual Studio 2008 VC++
- EzProg-I development tools:
  - EzConfig
  - EzHMI
  - EzGo
  - EzMake
  - EzLIB
- Software protection and license management

**Hardware**

- Powerful CPU Module
  - Intel Atom Z510 CPU (1.1 GHz)
- Memory size:
  - DDR2 SDRAM (512 MB), Built-in Flash Disk (2 GB)
  - EEPROM (16 KB), CF Card (1 GB)
  - Dual Battery Backup SRAM (512 KB)
- VGA Port x 1, USB 2.0 Ports x 4
- Programmable LED indicator x 2
- Audio with Microphone-In and Earphone-Out
- 64-bit Hardware Serial Number
- Dual Watchdog Timers
- 4 Serial Ports (RS-232/RS-485)
- Dual Giga bit Ethernet Ports (10/100/1000M)
- Redundant Power Input
- DIN-Rail or Wall Mounting
- Operating Temperature: -25 ~ +75 °C

**Applications**

Rich I/O Expansion Ability

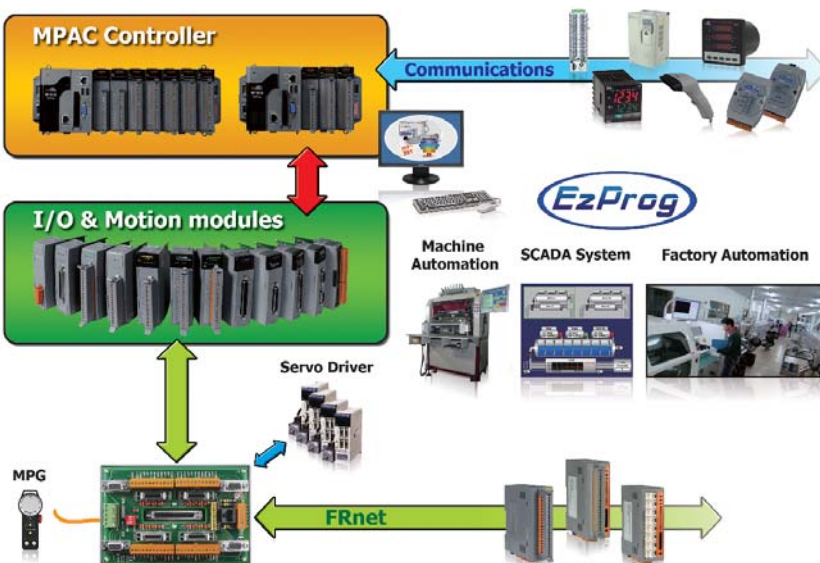

## Specifications

4

MotionPAC

3

MP-8000 Series

MP-8353/8753

Models	MP-8353	MP-8753
<b>System Software</b>		
OS	Windows CE 6.0 core version	
.Net Compact Framework	3.5	
Embedded Service	FTP Server, ASP (Java Script, VB Script), SQL Compact Edition 3.5	
SDK Provided	DII for Visual Studio .Net 2005/2008	
Multilanguage Support	English, German, French, Spanish, Russian, Italian, Japanese, Simplified Chinese, Traditional Chinese	
<b>CPU Module</b>		
CPU	Intel Atom Z510 CPU (1.1 GHz)	
System Memory	512 MB DDR2 SDRAM	
Dual Battery Backup SRAM	512 KB (for 5 years data retain while power off)	
Flash	2 GB as IDE Master	
EEPROM	16 KB Data Retention: 40 years; 1,000,000 erase/write cycles	
CF Card	Minimum 1 GB (support up to 32 GB)	
64-bit Hardware Serial Number	Yes, for Software Copy Protection	
Dual Watchdog Timers	Yes	
Rotary Switch	Yes (0 ~ 9)	
DIP Switch	Yes (8 bits)	
Audio	Microphone-In and Earphone-Out	
<b>VGA &amp; Communication Ports</b>		
VGA	Yes (resolution: 1024 x 768, 800 x 600, 640 x 480)	
Ethernet (Giga bit)	RJ-45 x 2, 10/100/1000 Base-TX (Auto-negotiating, Auto MDI/MDI-X, LED indicators)	
USB 2.0	4	
COM 1	Internal communication with I-87K modules in slots	
COM 2	RS-232 (RxD, TxD and GND); non-isolated	
COM 3	RS-485	D2+, D2-; self-tuner ASIC inside
	Isolation	3000 V <sub>oc</sub>
COM 4	RS-232/RS-485 (RxD, TxD, CTS, RTS and GND for RS-232, Data+ and Data- for RS-485); non-isolated	
COM 5	RS-232 (RxD, TxD, CTS, RTS, DSR, DTR, CD, RI and GND); non-isolated	
<b>I/O Expansion Slots</b>		
Slot Number	3	7
Support modules type	High profile modules only	
<b>Mechanical</b>		
Dimensions (W x L x H)	231 mm x 132 mm x 125 mm	355 mm x 132 mm x 111 mm
Installation	DIN-Rail or Wall Mounting	
<b>Environmental</b>		
Operating Temperature	-25 ~ +75 °C	
Storage Temperature	-30 ~ +80 °C	
Ambient Relative Humidity	10 ~ 90% RH, non-condensing	
<b>Power</b>		
Input Range	+10 ~ +30 V <sub>oc</sub>	
Isolation	1 kV	
Redundant Power Inputs	Yes, with one power relay (1 A @ 24 V <sub>oc</sub> ) for alarm	
Capacity	1.8A, 5V supply to CPU and backplane, 5.2A, 5V supply to I/O expansion slots, total 35 W	2.0A, 5V supply to CPU and backplane, 5.0A, 5V supply to I/O expansion slots, total 35 W
Consumption	14.4 W (0.6 A @ 24 V <sub>oc</sub> )	16.8 W (0.7 A @ 24 V <sub>oc</sub> )

Appearance

MP-8353

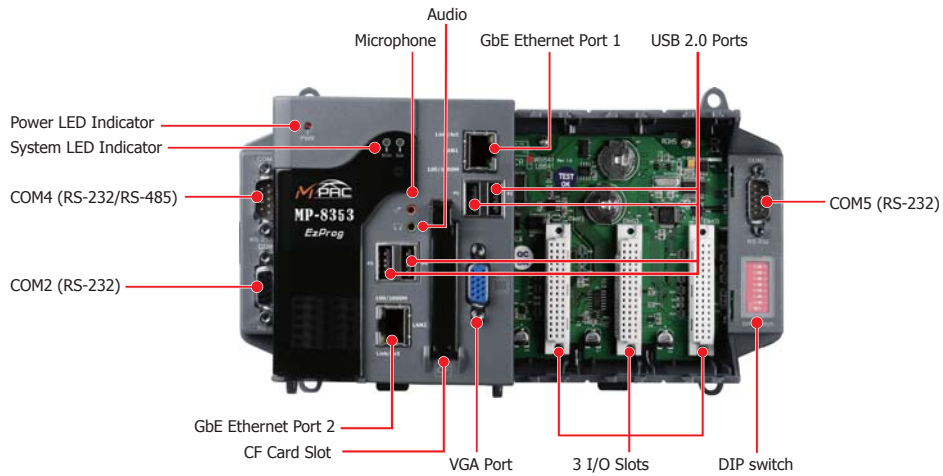

MP-8753

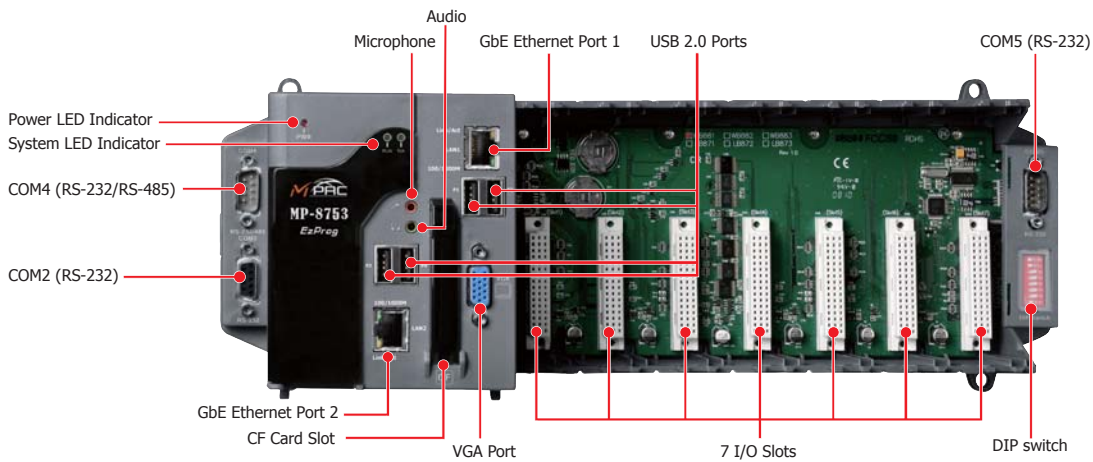

Pin Assignments

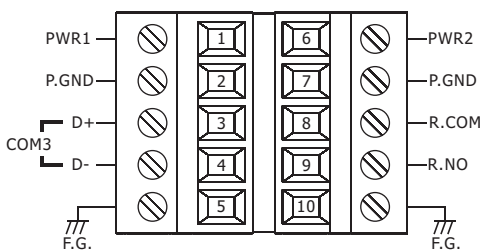

COM2: RS-232

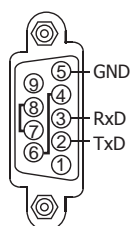

COM4: RS-232/RS-485

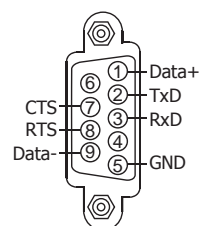

COM5: RS-232

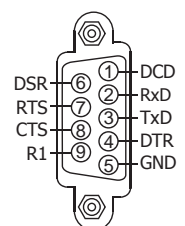

▣ Dimensions (Units: mm)

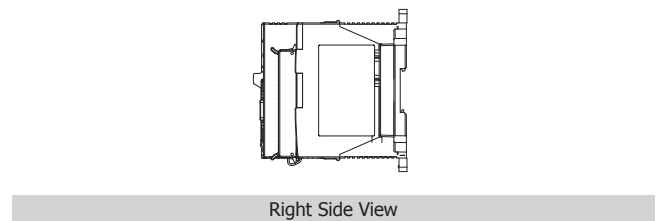
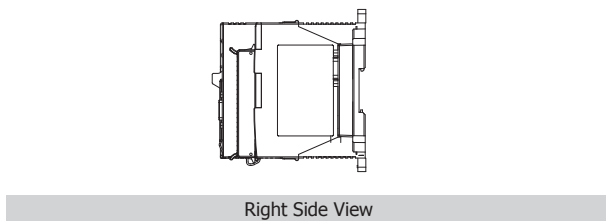
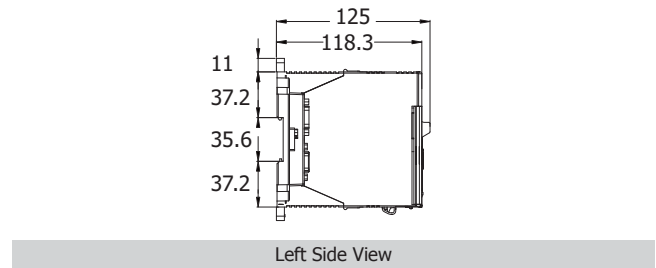
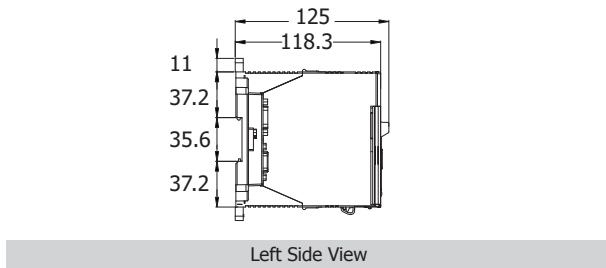
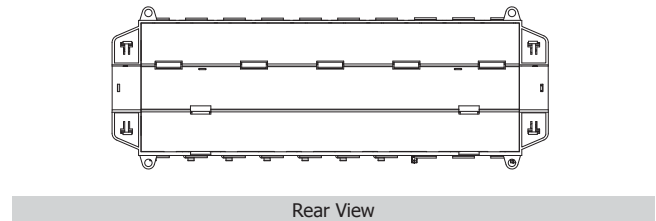
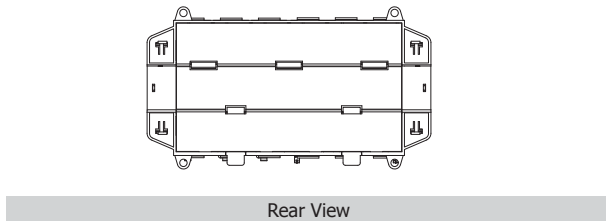
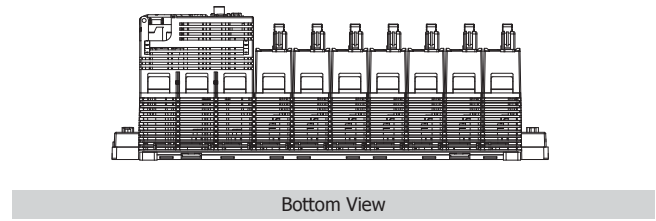
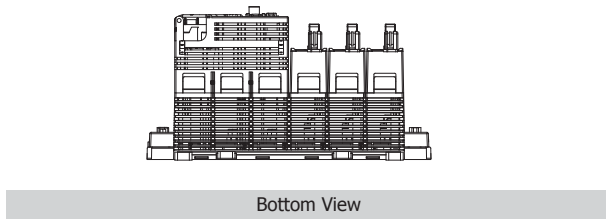
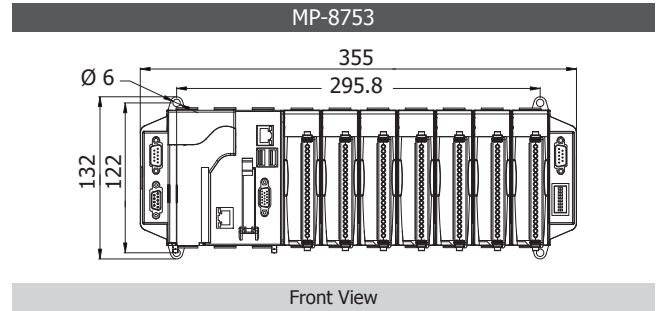
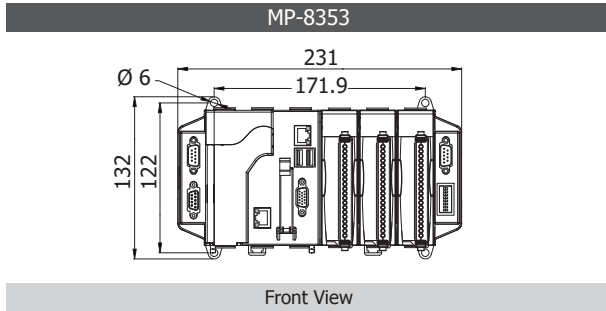

▣ Ordering Information

MP-8353 CR	Standard MP-8353-Atom with 3 I/O Slots (Multilingual Version of OS) (RoHS)
MP-8753 CR	Standard MP-8753-Atom with 7 I/O Slots (Multilingual Version of OS) (RoHS)

▣ Accessories

USB-2020 CR	USB Audio Device (RoHS)
USB-2560 CR	4-Port Industrial USB 2.0 Hub (RoHS)
NS-208 CR	8-Port Unmanaged Industrial 10/100 Base-TX Ethernet Switch (RoHS)
MDR-20-24 CR	24 V <sub>dc</sub> /1.0 A, 24 W Power Supply with DIN-Rail Mounting (RoHS)
MDR-60-24 CR	24 V <sub>dc</sub> /2.5 A, 60 W Power Supply with DIN-Rail Mounting (RoHS)